



University of Belgrade  
Faculty of Mathematics  
Department of Astronomy



# Dark matter halos in galaxy mergers

Stanislav Milošević  
stanislav@matf.bg.ac.rs

XIII BSAC  
Velingrad, Bulgaria  
October, 2022

# Introduction

- Galaxies are a building blocks of the Universe
- In the bottom-up model of galaxy formation, large mass galaxies are formed through mergers of smaller galaxies.

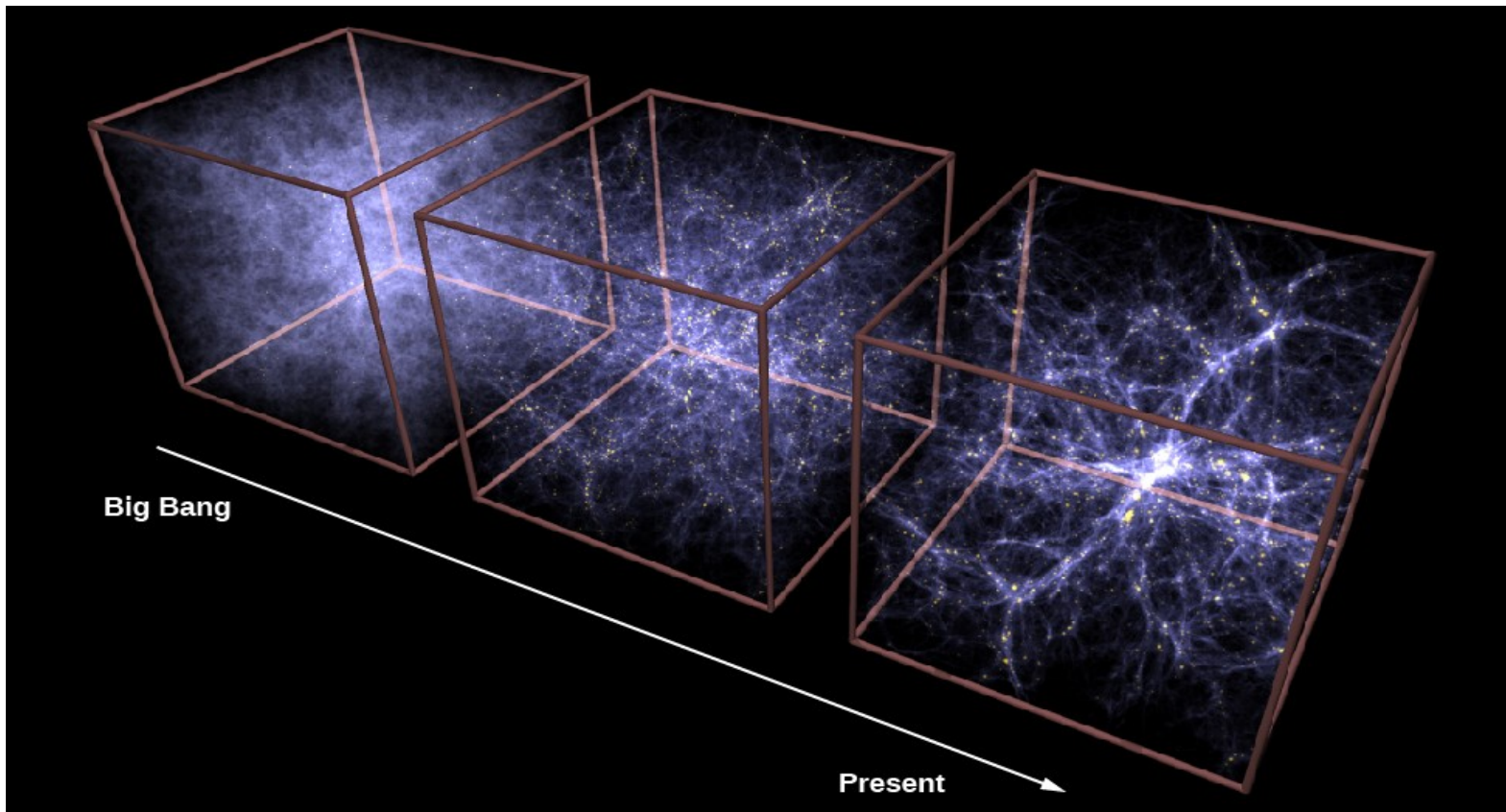

Credit: V. Springel

$Z=28.62$

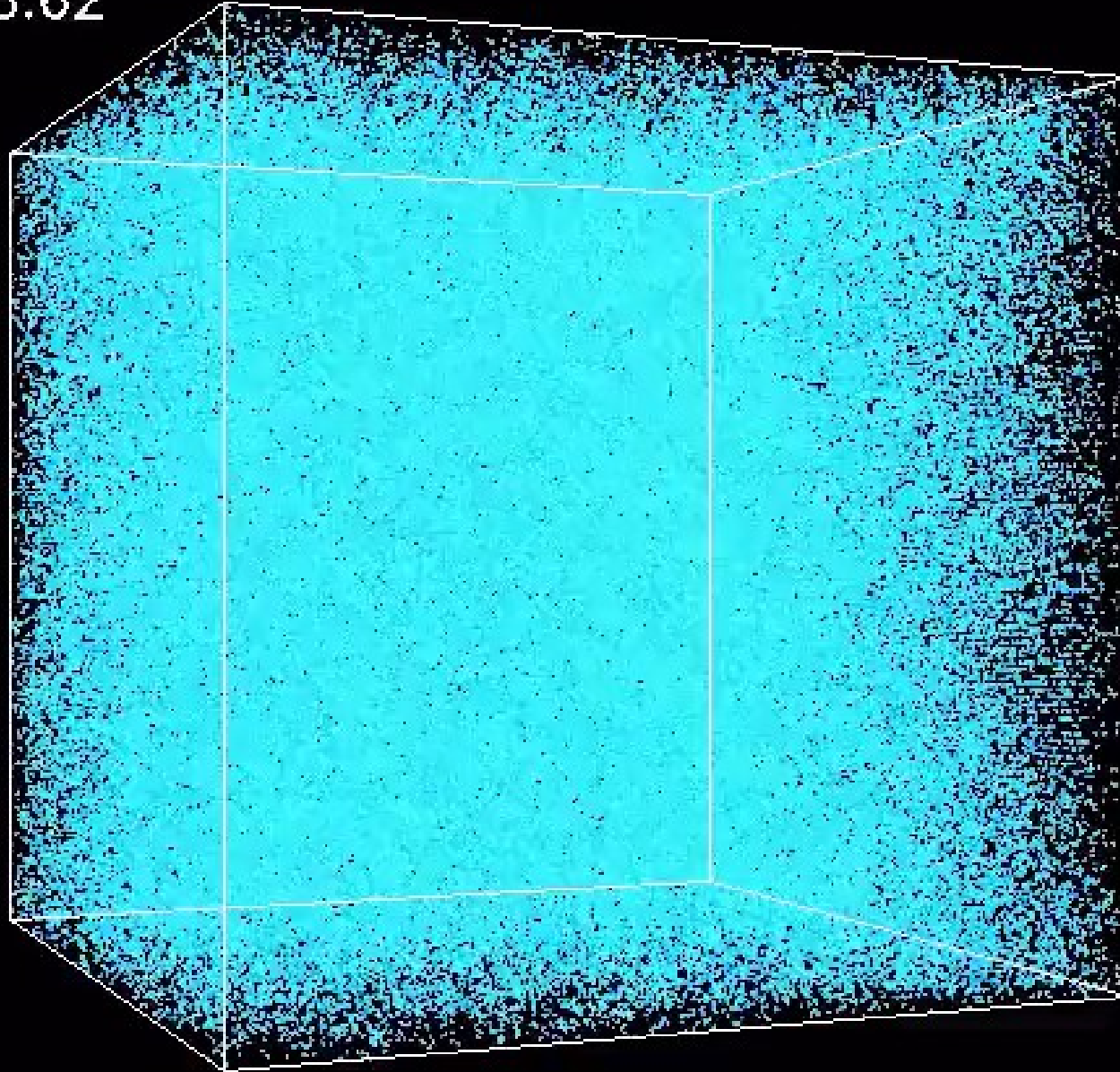

# Morphology classification

Different morphologies,  
masses, formation histories

## Hubble "Tuning Fork" Diagram

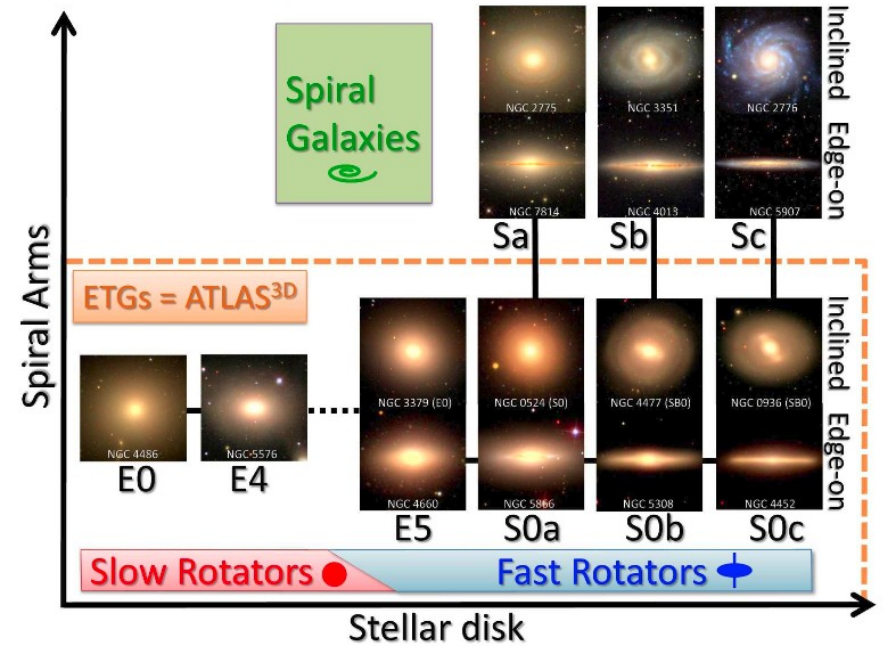
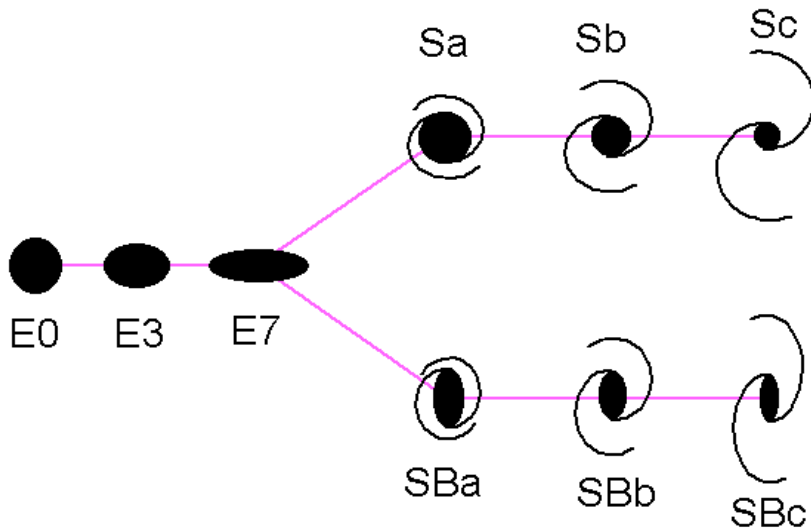

Cappellari et al. 2011

# Spiral galaxies

- Disk stability (Toomre)
- Galactic rotation curves (Rubin)
- Dark matter in galaxy clusters (Zwicky)

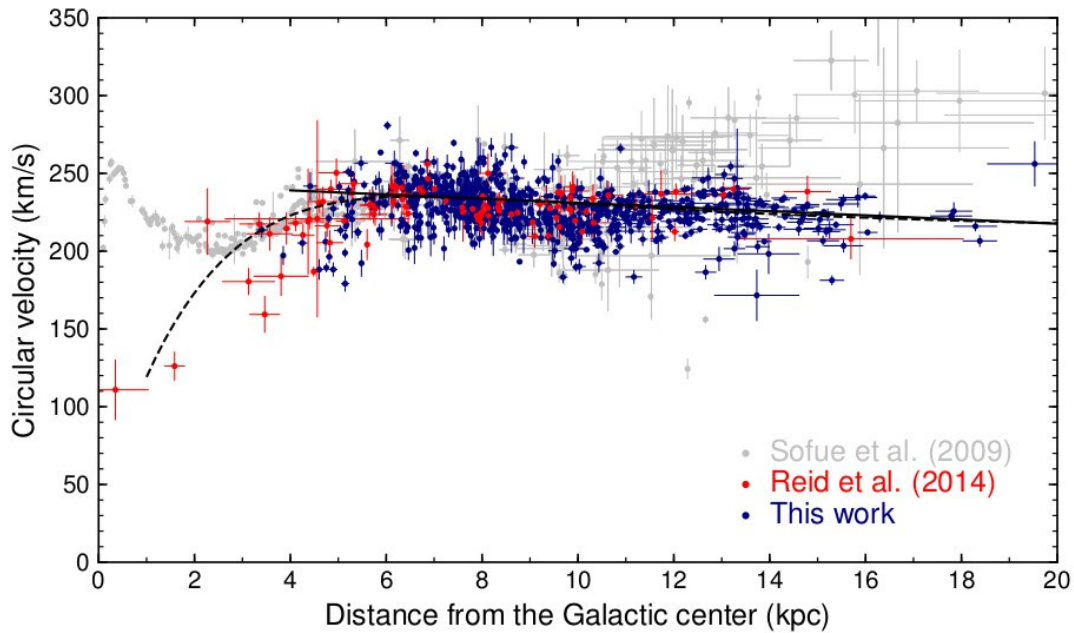

Mroz et al. 2019

# Galaxy interactions

- Tidal disruption
- Tidal striping
- Fly bys
- Mergers

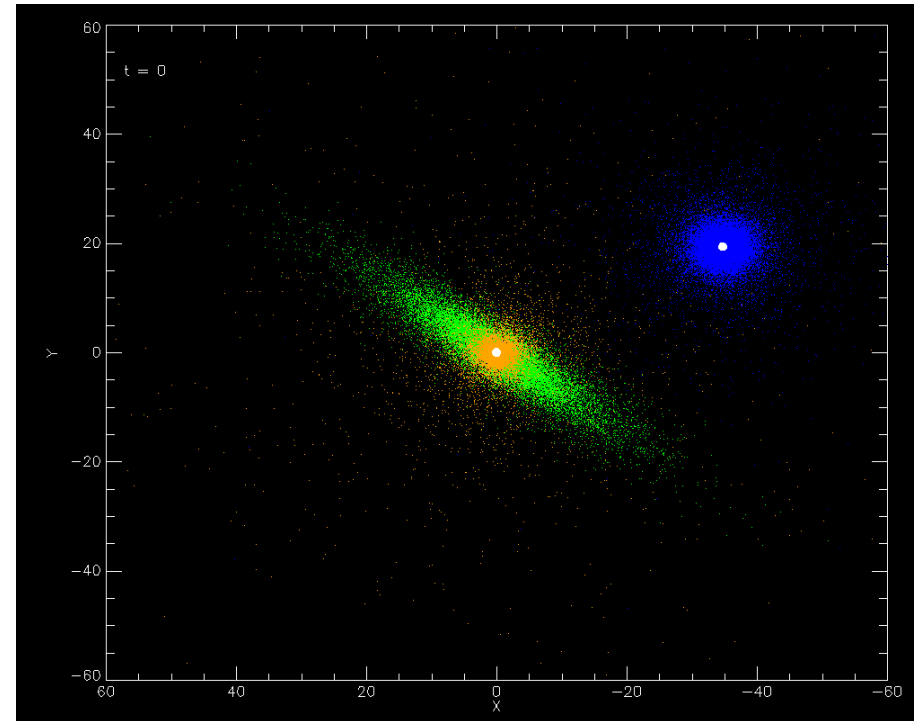
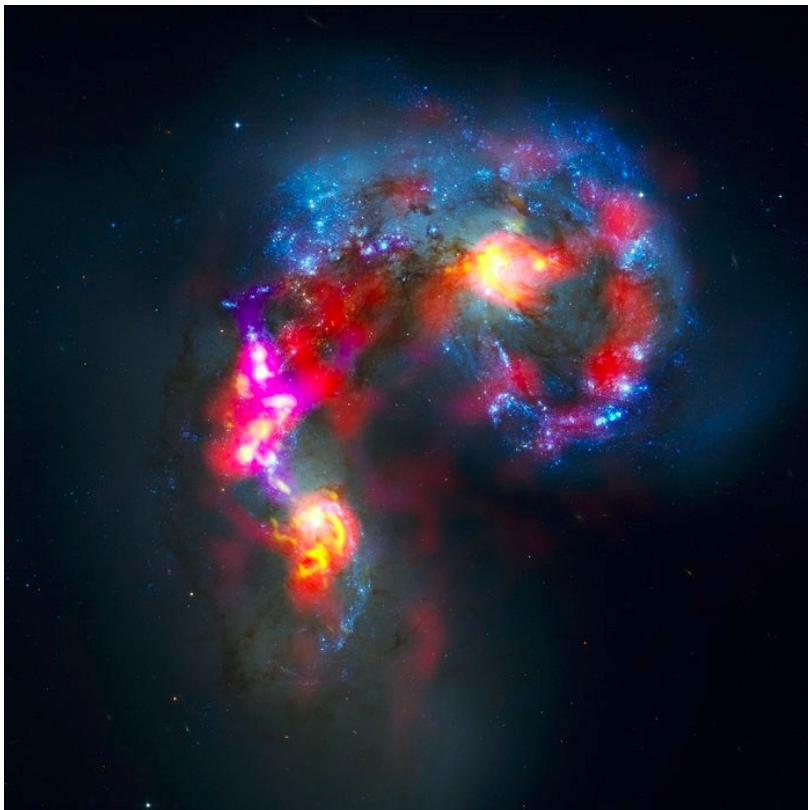

Fardal et al. 2003

# Dynamical friction

- Important for mergers
- Accounted in N-body models

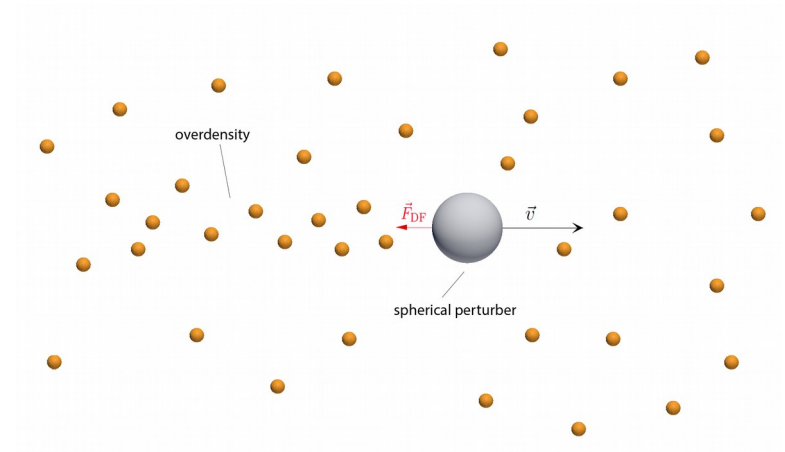
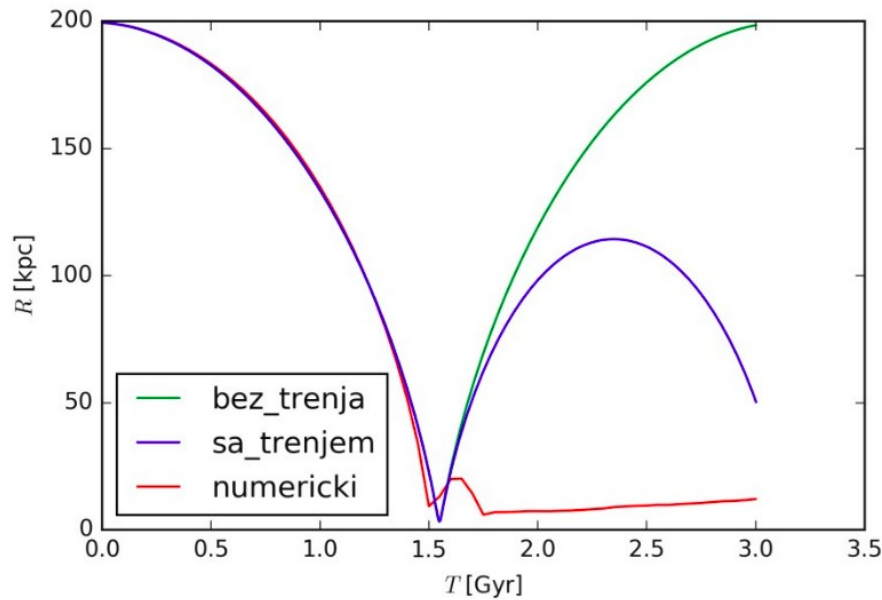

# Model of the spiral galaxy

(Geehan et al. 2006; Sadoun et al. 2014)

Disk

$$\Sigma(R) = \Sigma_0 e^{\frac{-R}{R_d}} = \frac{M_d}{2\pi R_d^2} e^{\frac{-R}{R_d}}$$

$$\propto \operatorname{sech}^2 \frac{z}{z_0}$$

$$\rho(R, z) = \frac{\Sigma(R)}{2z_0} \operatorname{sech}^2 \frac{z}{z_0}$$

Bulge

$$\rho_b = \frac{M_b r_b}{2\pi r (r + r_b)^3}$$

**Halo (NFW, Navarro et. al 1996)**

$$\rho_h(r) = \frac{\rho_0}{\frac{r}{r_h} \left(1 + \frac{r}{r_h}\right)^2}$$



# Stellar stream in M31

- The Giant Southern Stream is a faint stellar structure
- Analytical simulation (Fardal et al. 2007)
- N-body simulation (Sadoun et al. 2014; Micky & Mory 2016; Milošević et al. 2022)
- Observations (Ibata et al. 2001; McConnachie et al. 2003, Ibata et al. 2004, Conn et al 2016; Cohen et al. 2018, Escala et al. 2020)
  
- Timescale of the merger event
- Physical properties
  
- Initial conditions were generated with GalactICs package (Widrow et al. 2008)
- We ran simulations with Gadget 2 code (Springel 2005)

# Dark matter halo

t= 0 Gyrs

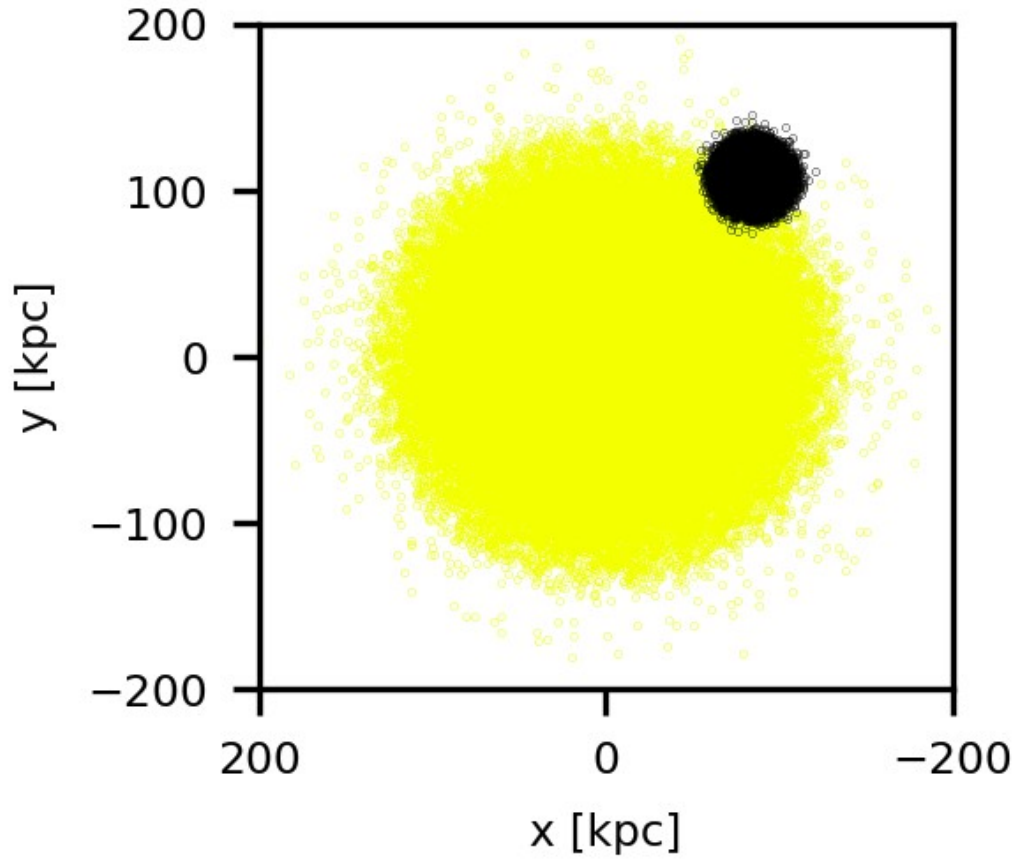

t= 1.5 Gyrs

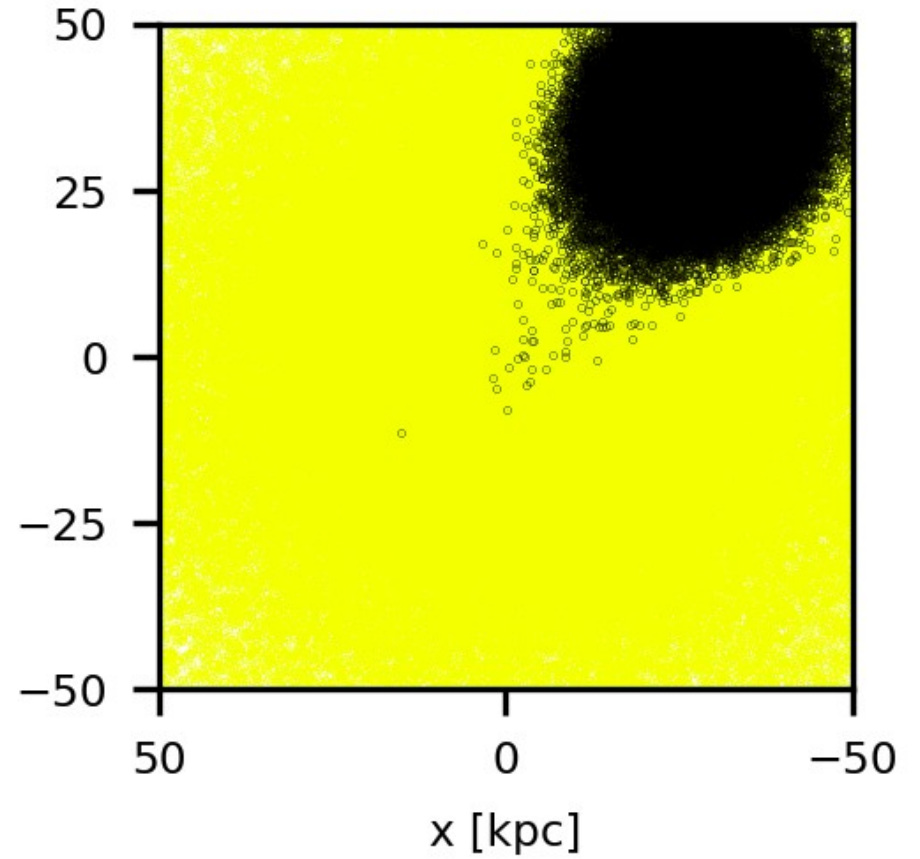

# Baryonic matter

t= 0 Gyrs

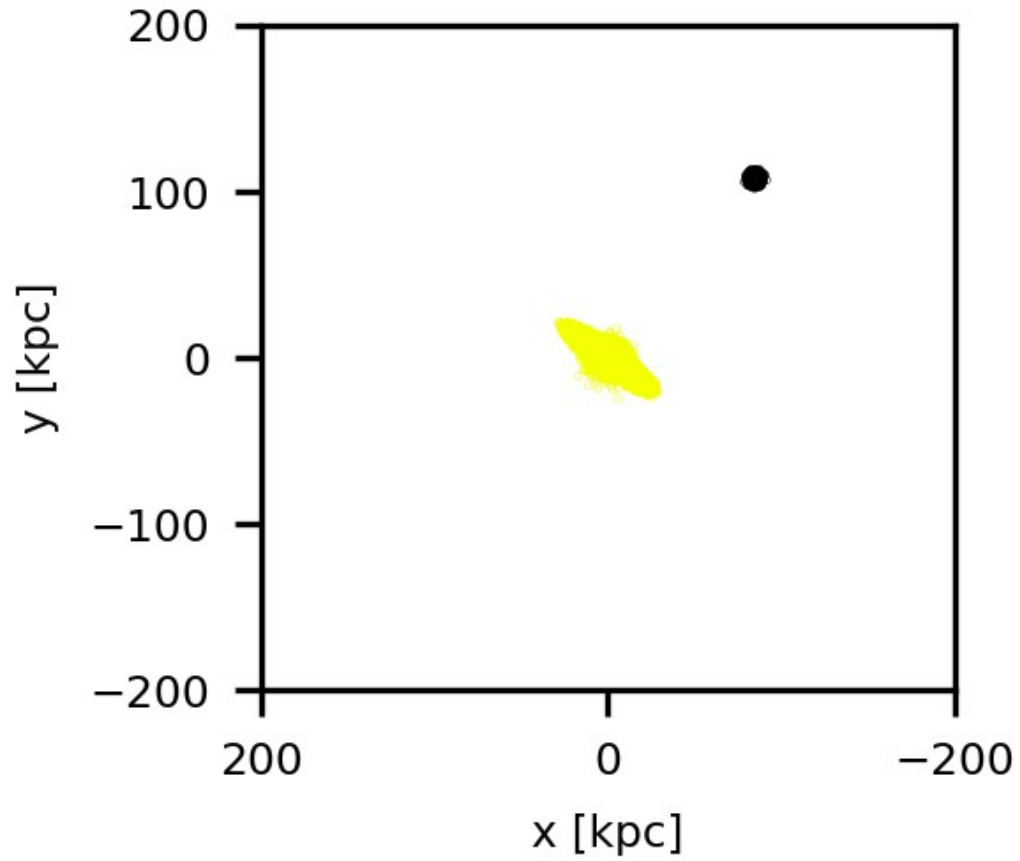

t= 1.5 Gyrs

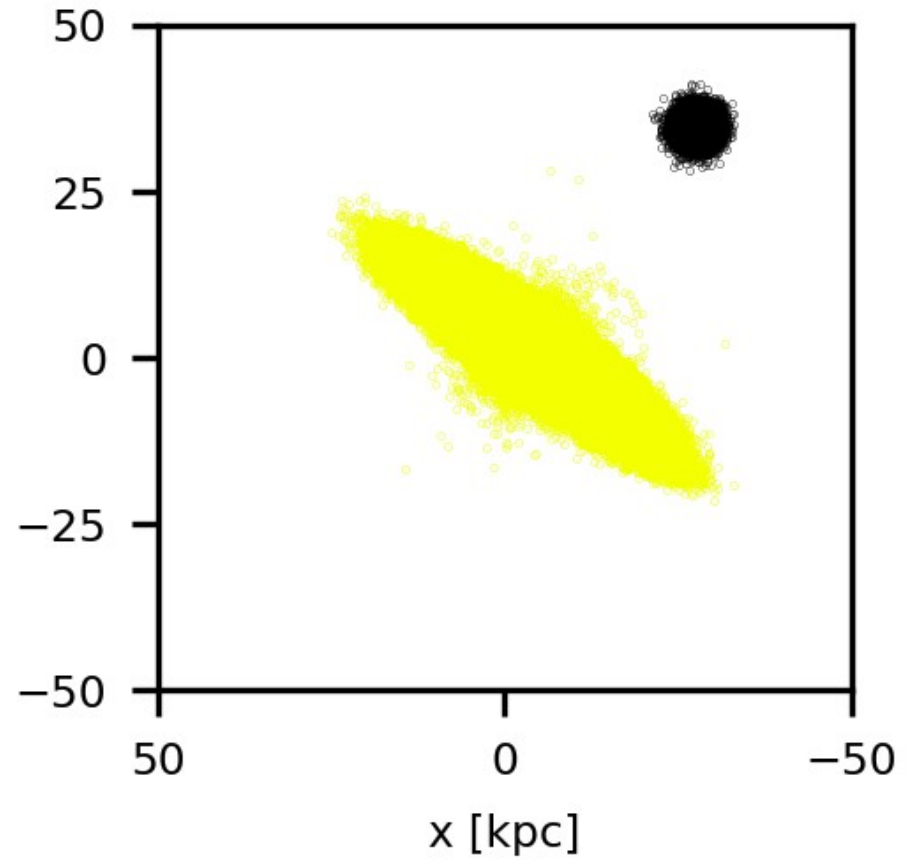

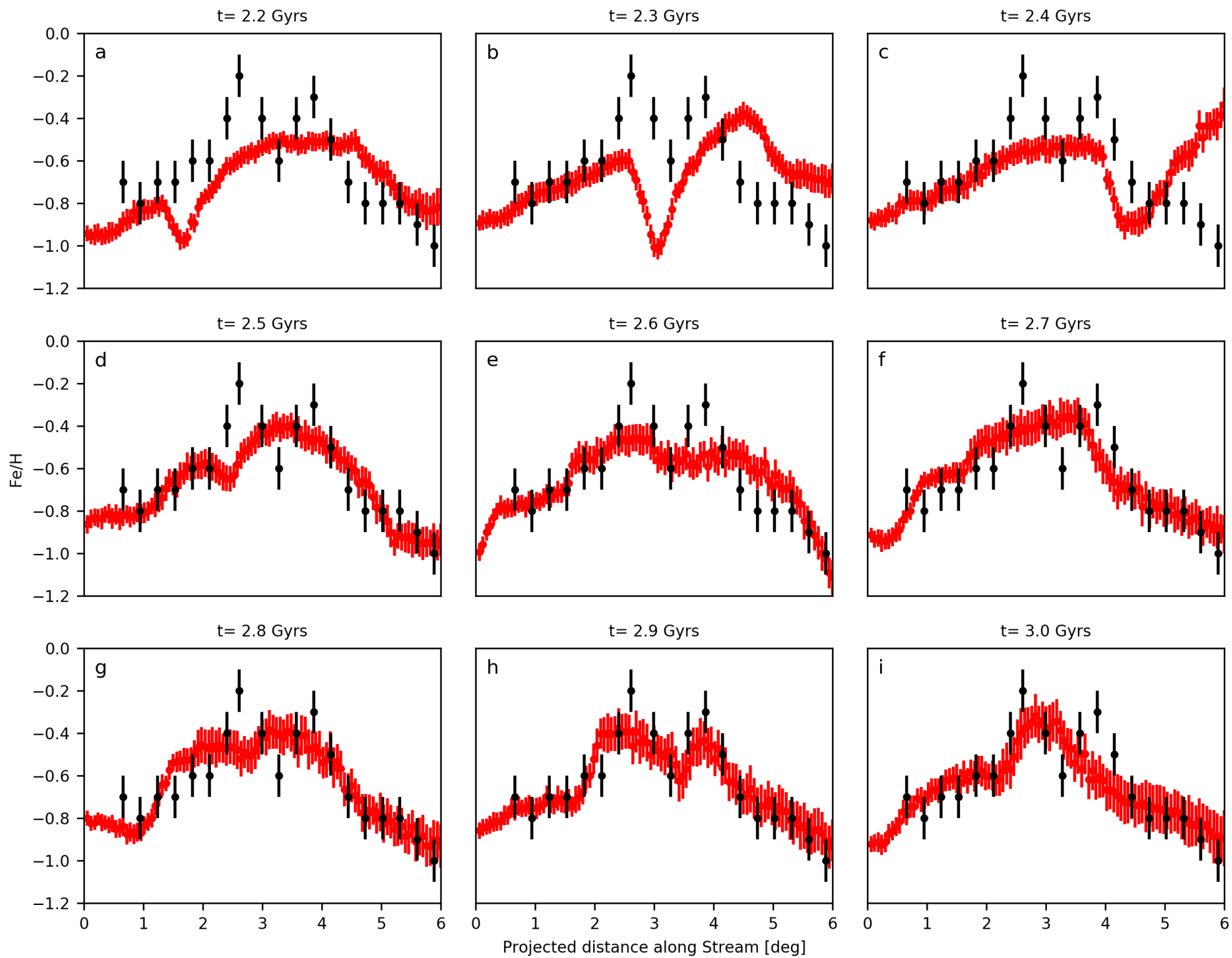

t=1.6Gyrs

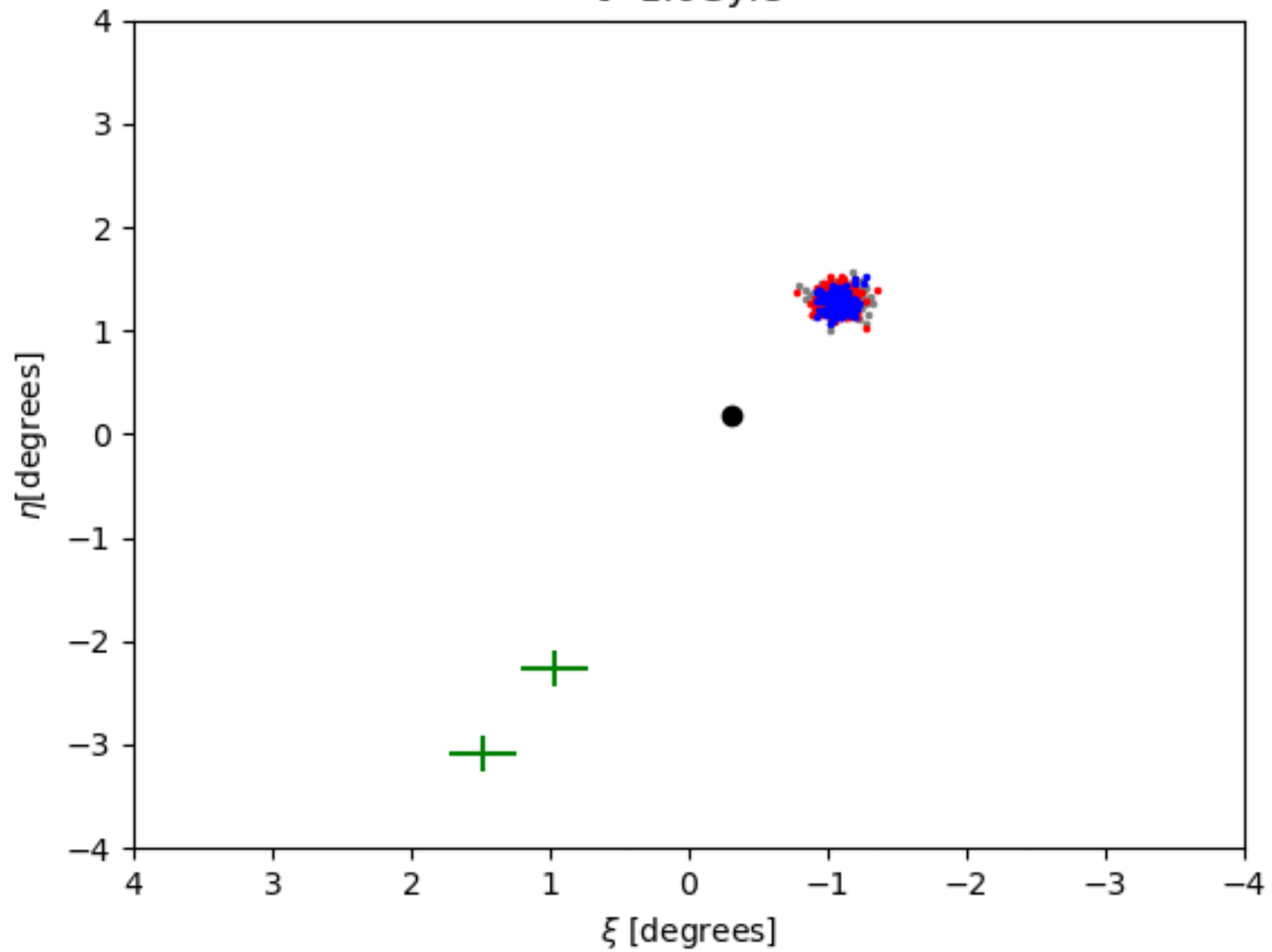

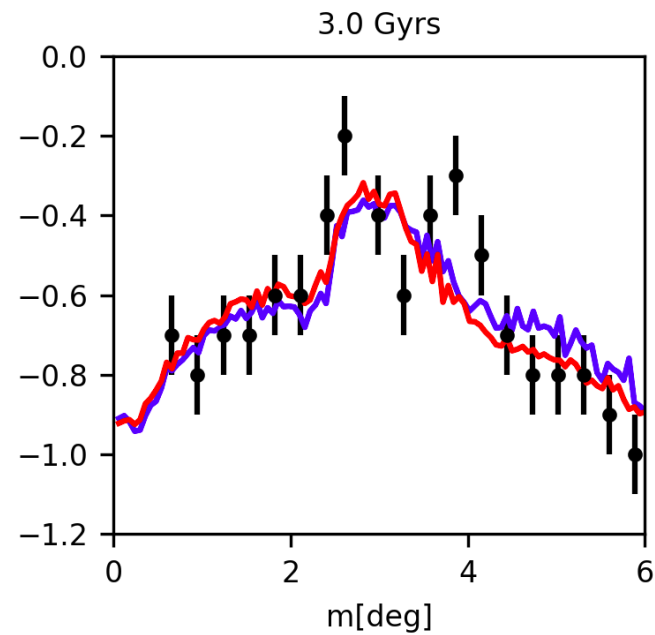
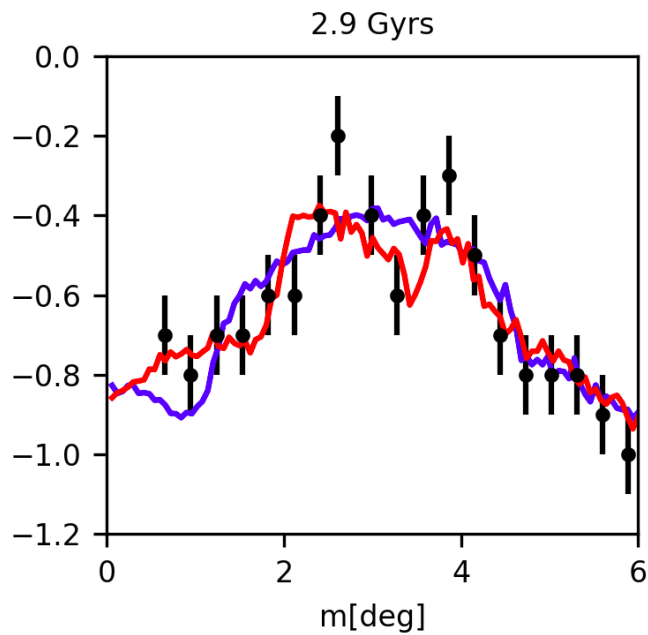
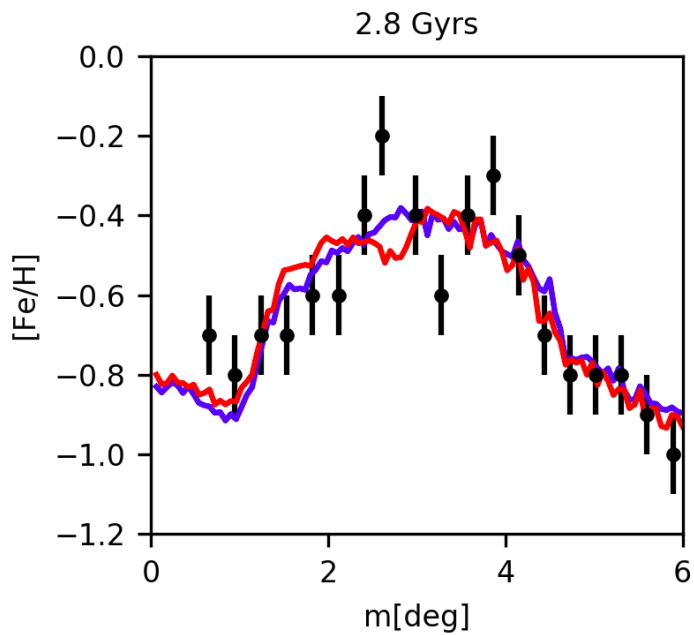
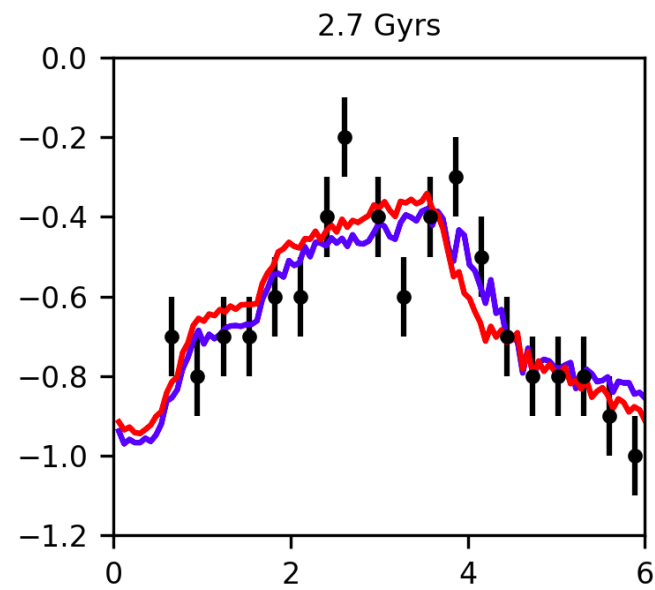
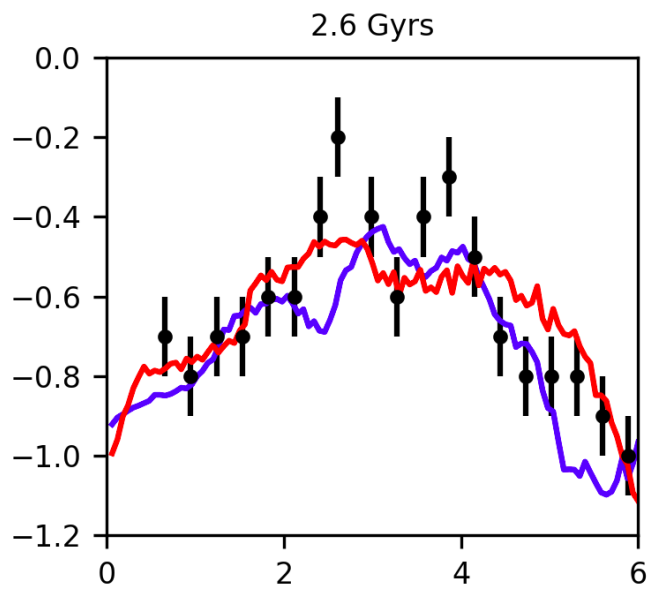
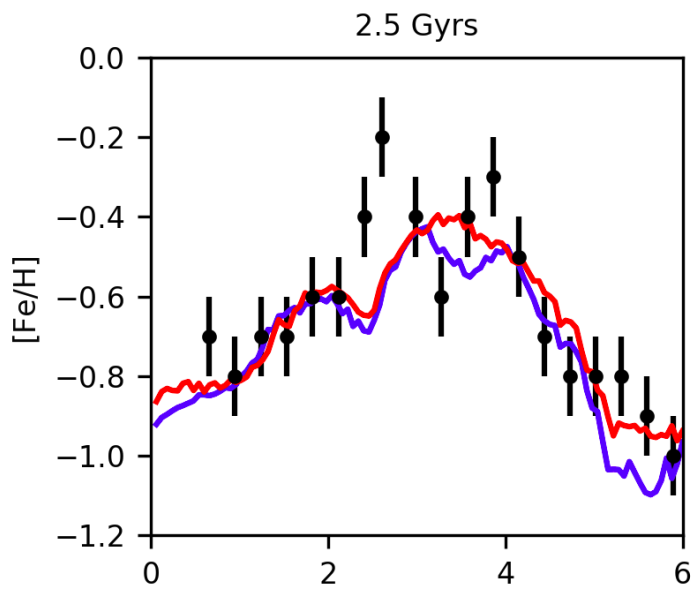

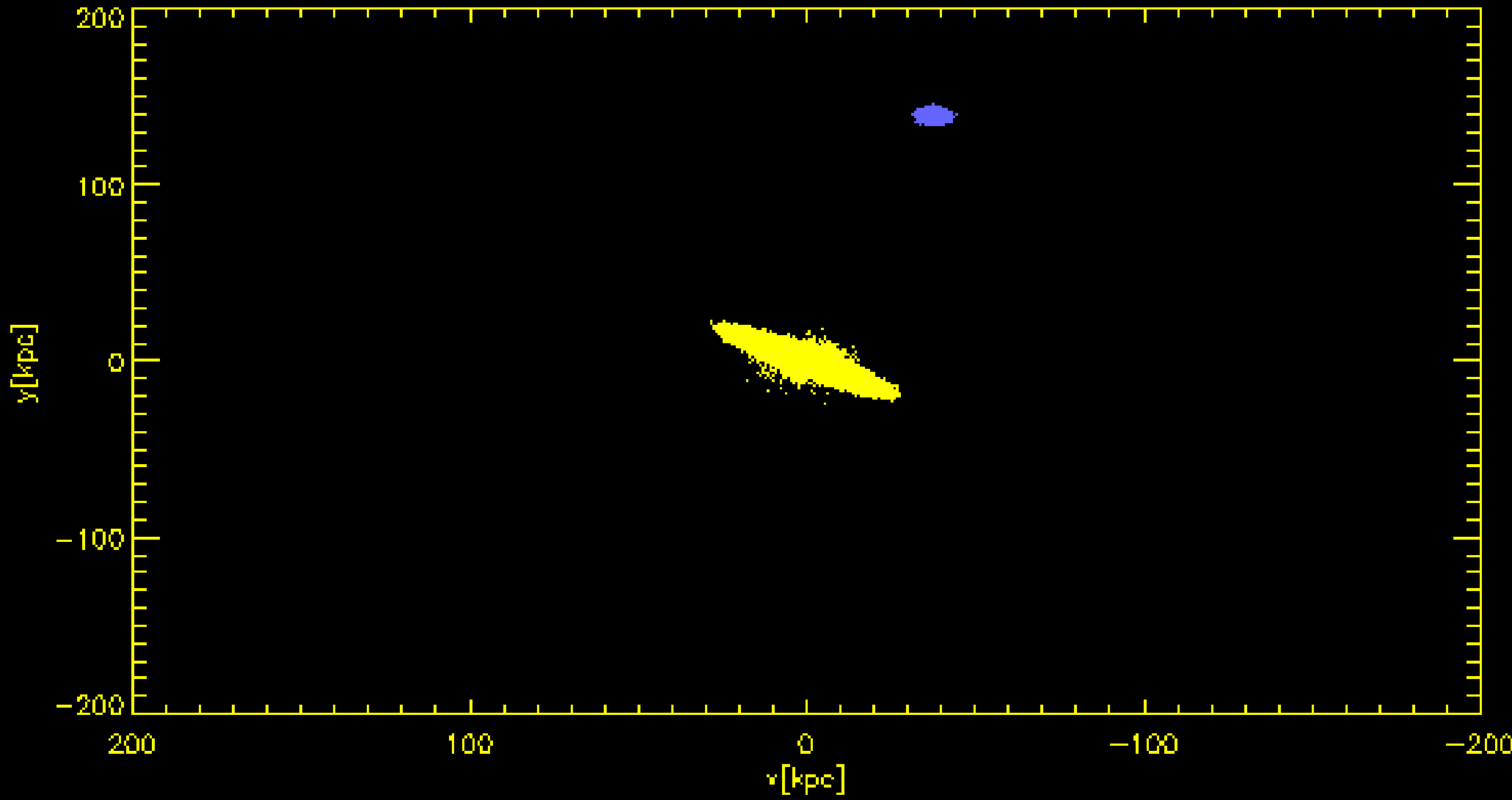

# Simulations of shells in galaxies

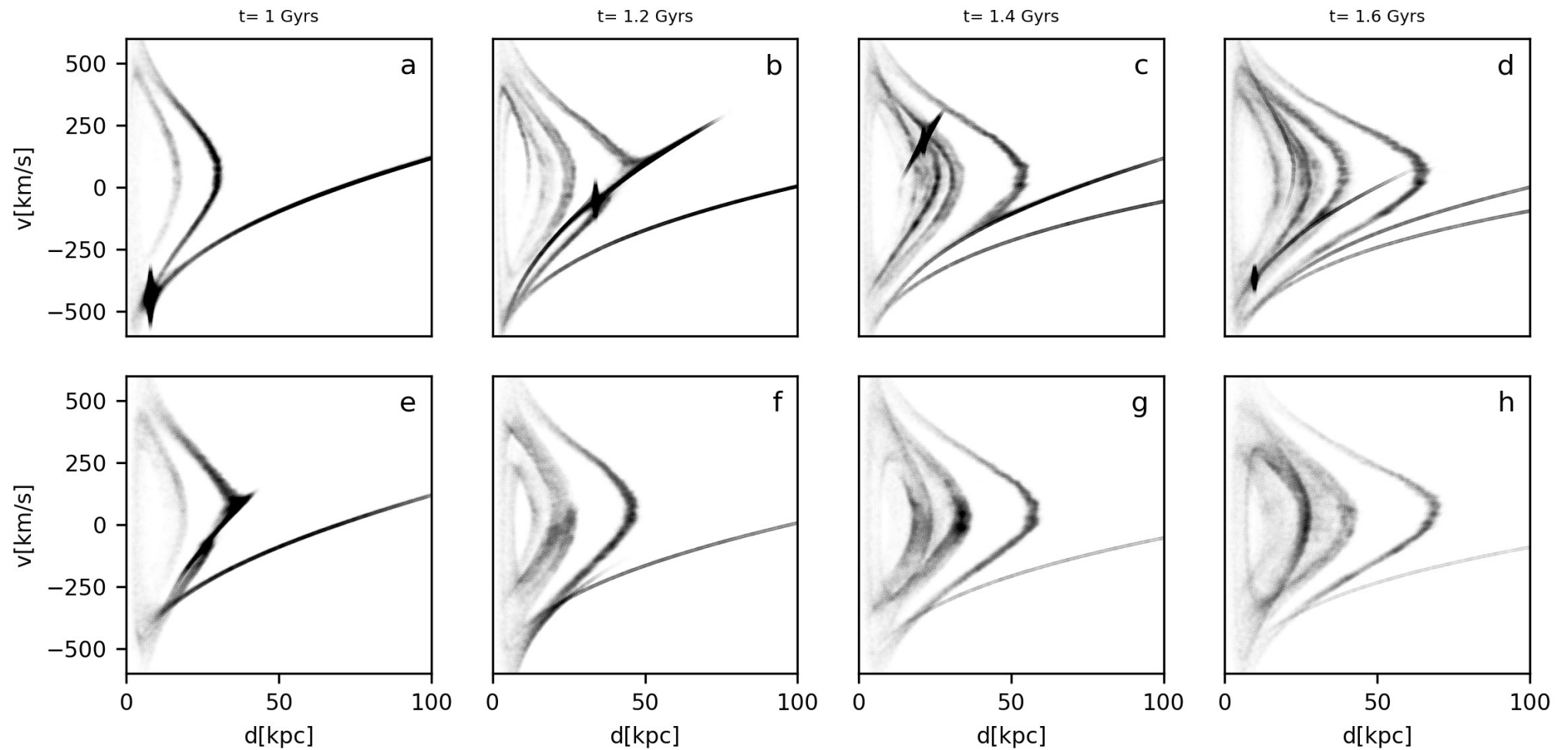



# Summary

- Density fluctuations and structure formation
- We use pure N-body simulation to describe dynamical history of galaxies
- Orbits of galaxies and tidal disruption
- Morphological substructures formation and timescale of events
- Mass of the dark matter halos in host and satellite galaxies
- Mass of the galaxies
- Future: gas in galaxies, other models for dark matter, and particle physics approach

Thank you!

