



Progress Report

University of Córdoba- Physics Department

Plasma Technology as a new Preservation Technique

R. Rincón and M. D. Calzada

June 2011





Plasma Technology as a new Preservation Technique

- ➔ On the use of Plasma Technology as a food preservation Technique
- ➔ Active species and UV radiation un Surface Wave Discharges (SWDs)
- ➔ Action of a Surface Wave Discharge on browning of sherry Fino wine and growth rate in lentils
- ➔ Conclusions



Plasma Technology as a new Preservation Technique

- ➔ On the use of Plasma Technology as a food preservation Technique
- ➔ Active species and UV radiation un Surface Wave Discharges (SWDs)
- ➔ Action of a Surface Wave Discharge on browning of sherry Fino wine and growth rate in lentils
- ➔ Conclusions



On the use of Plasma Technology as a food preservation Technique

➔ One serious problem for food industry is the deterioration of foods during the storage

➔ The consumers are increasing their demands related to the use of the preservation process



To improve food preservation techniques

To develop NEW food preservation techniques

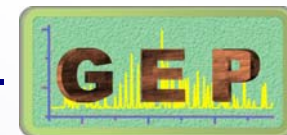



On the use of Plasma Technology as a food preservation Technique

To develop NEW food preservation techniques

Non-thermal alternative Technology	Process
HPP (High Pressure Processing)	Food is exposed to a high hydrostatic pressure for a few minutes
PEF (Pulsed Electric Field)	Food is exposed to pulses at high electric field intensity for a few milisecons
Ionizing radiations	Food is exposed to gamma radiation and electron beam with doses of 2-10kGy
Ultraviolet (UV) Energy	Food is exposed to non-ionizing radiation with germicidal properties
Plasma ???	





On the use of Plasma Technology as a food preservation Technique

Plasma Sterilization:

Sterilization is an act or process, physical or chemical, that destroys or eliminates all form of life.

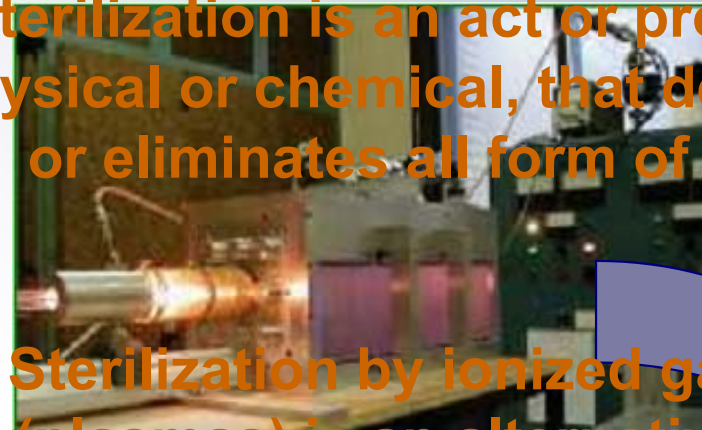

Sterilization by ionized gases (plasmas) is an alternative to conventional sterilization systems

Active Species

+

UV Photons

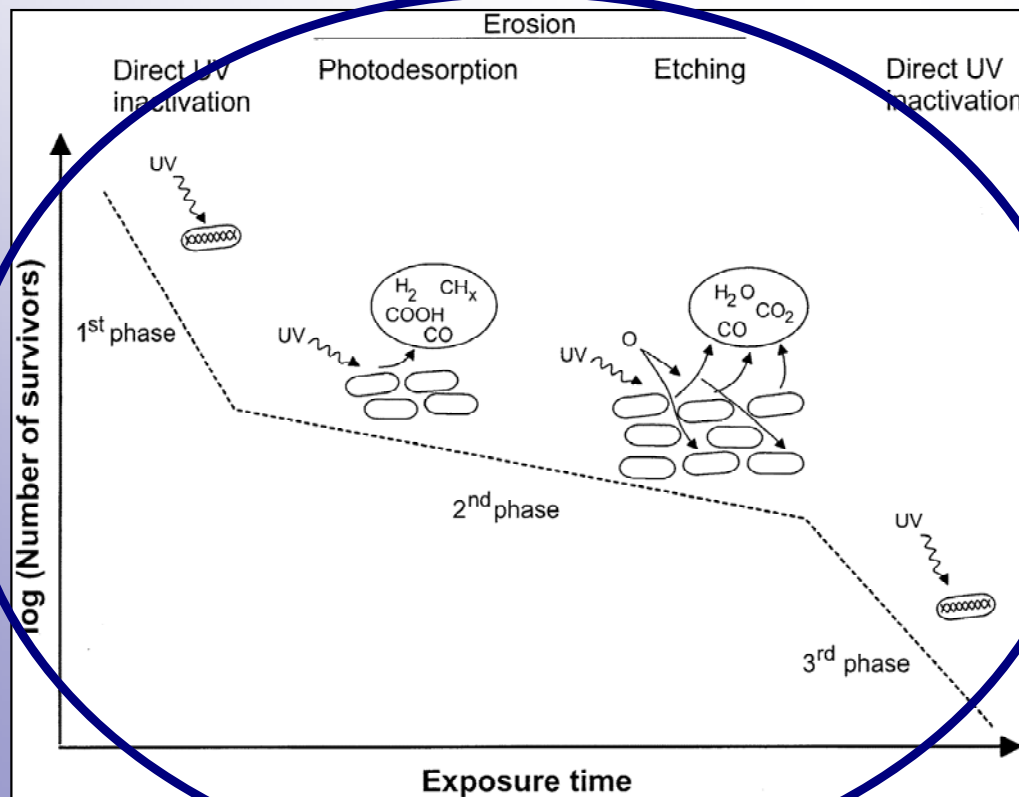



On the use of Plasma Technology as a food preservation Technique

Non-thermal alternative Technology	Process
HPP (High Pressure Processing)	Food is exposed to a high hydrostatic pressure for a few minutes
PEF (Pulsed Electric Field)	Food is exposed to pulses at high electric field intensity for a few milisecons
Ionizing radiations	Food is exposed to gamma radiation and electron beam with doses of 2-10kGy
Ultraviolet (UV) Energy	Food is exposed to non-ionizing radiation with germicidal properties
Plasma	Food is exposed to active species like metastable $N_2(A^3\Sigma_u^+)$ and UV photons in the range of 200-280 nm such as those emitted by NO_γ band





Plasma Technology as a new Preservation Technique

- ➔ On the use of Plasma Technology as a food preservation Technique
- ➔ Active species and UV radiation un Surface Wave Discharges (SWDs)
- ➔ Action of a Surface Wave Discharge on browning of sherry Fino wine and growth rate in lentils
- ➔ Conclusions



Active species and UV radiation in Surface Wave Discharges (SWDs)

➔ **Objective:** To find active species and UV photons using plasma technology

➔ **How?:** 1. Kind of plasma: Surface Wave Discharge (SWD)

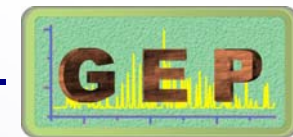
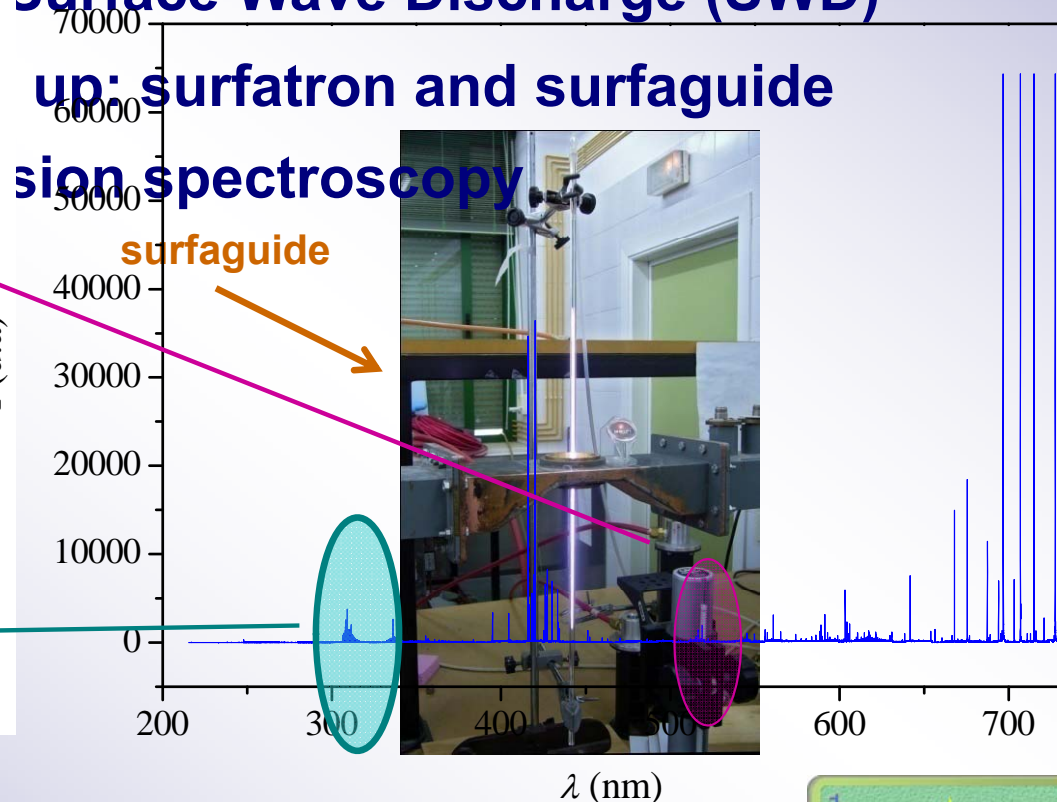
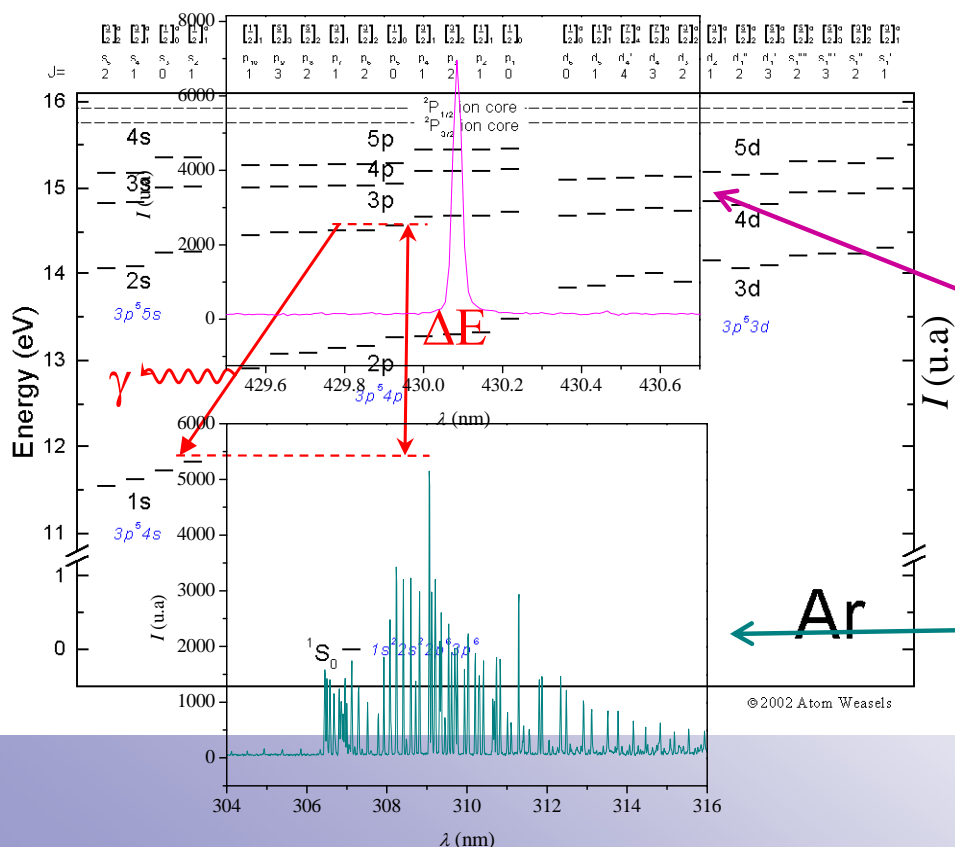



Active species and UV radiation in Surface Wave Discharges (SWDs)

➔ UV photons: de-excitation of $\text{NO}(\text{A}^2\Sigma^+)$ → UV radiation: 220-260 nm

Ar-N₂(4.90-0.10 slm)

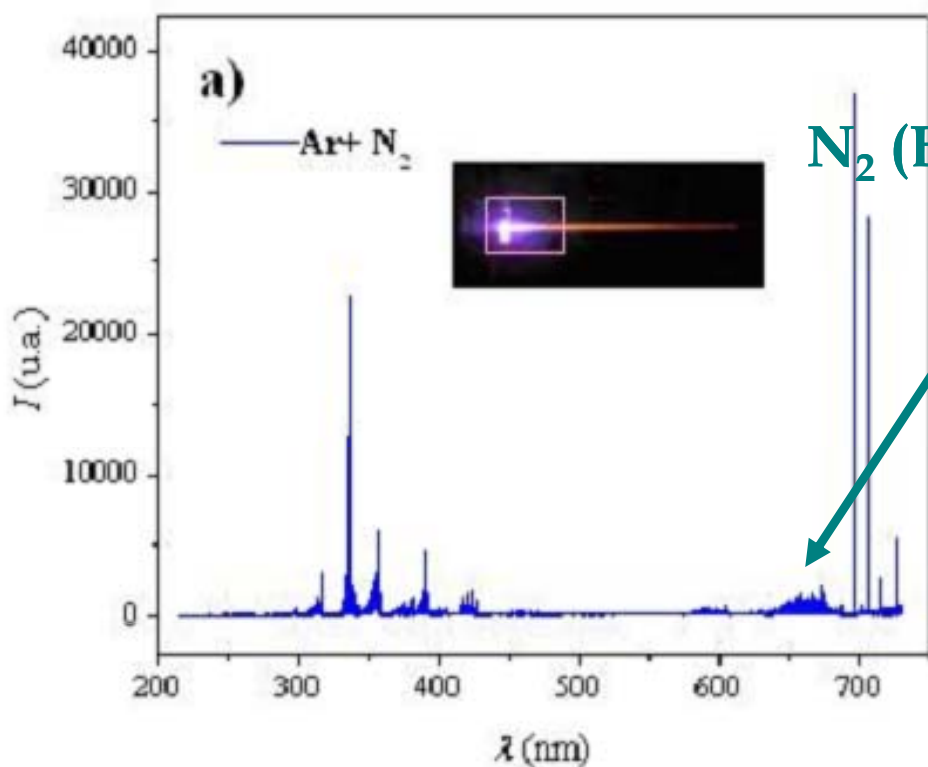

$\text{N}_2 (\text{B}^3\Pi_g \rightarrow \text{A}^3\Sigma_u^+)$

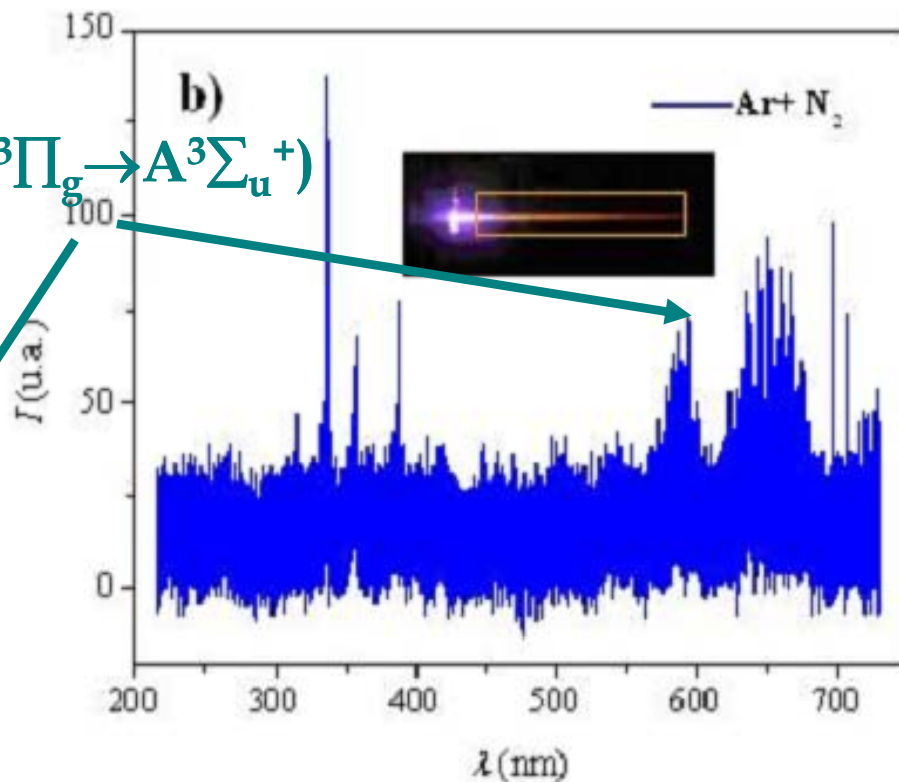

ge
all





Active species and UV radiation in Surface Wave Discharges (SWDs)

➔ UV photons: de-excitation of $\text{NO}(\text{A}^2\Sigma^+)$ → UV radiation: 220-260 nm

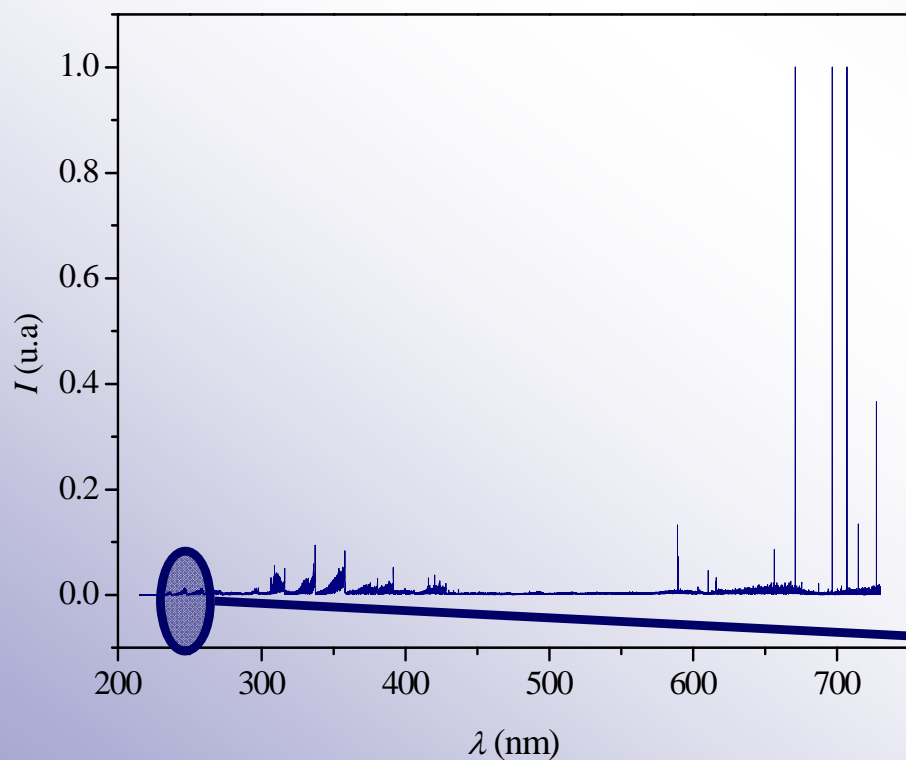

Ar-N₂O (4.90-0.05 slm)

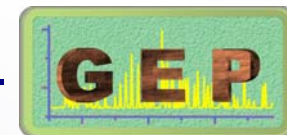
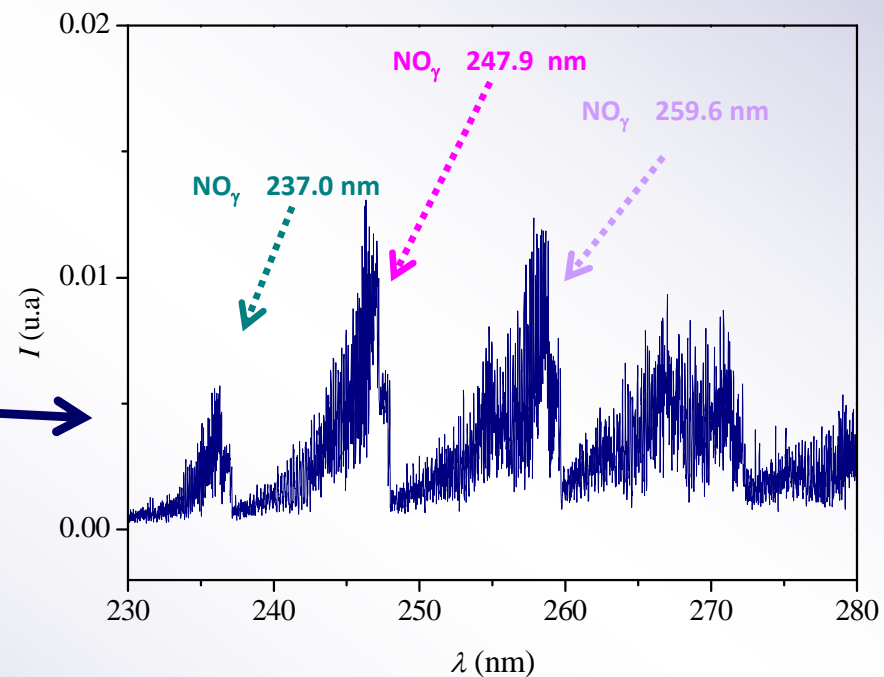



Plasma Technology as a new Preservation Technique

- ➔ On the use of Plasma Technology as a food preservation Technique
- ➔ Active species and UV radiation un Surface Wave Discharges (SWDs)
- ➔ Action of a Surface Wave Discharge on browning of sherry Fino wine and growth rate in lentils
- ➔ Conclusions



Action of a SWDs on Food: lentils and Sherry Fino wine

➔ LENTILS TREATMENTS:

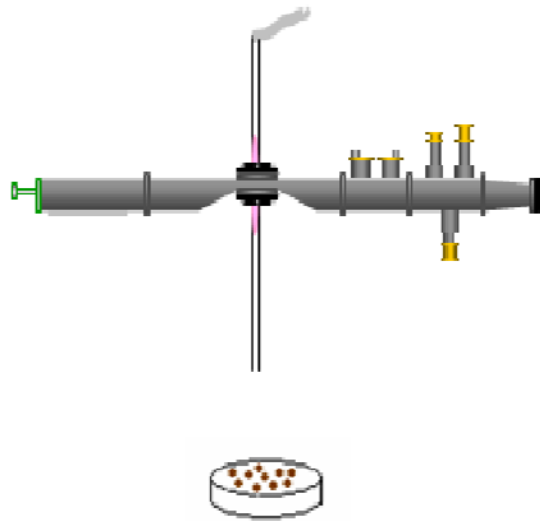

Mixture of Ar-N₂(I)
(0.49 - 0.05 slm)

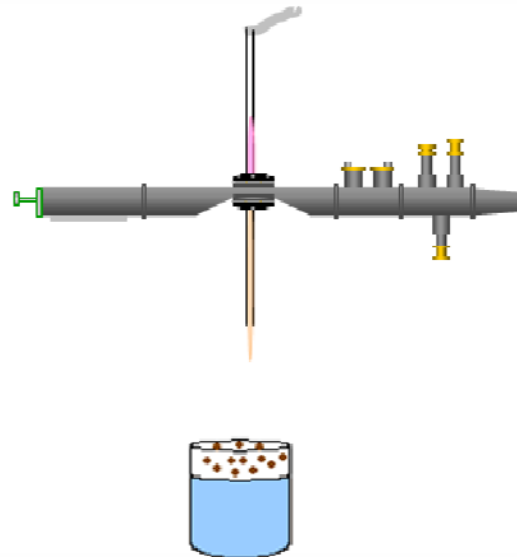

Mixture of Ar-N₂(II)
(4.90 - 0.10 slm)

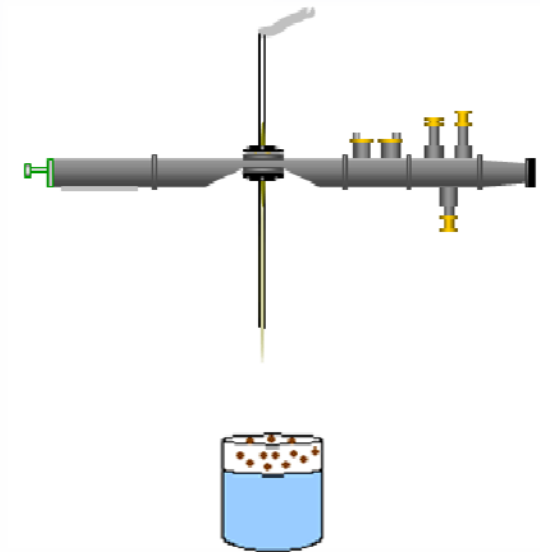

Mixture of Ar-N₂O
(4.90 - 0.05 slm)





Action of a SWDs on Food: lentils and Sherry Fino wine

➔ LENTILS TREATMENTS:



CONTROL
GROUP OF
LENTILS

Ar-N₂(I)

Ar-N₂ (II)

Ar-N₂O

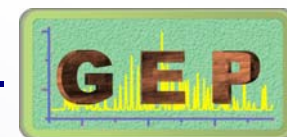



Action of a SWDs on Food: lentils and Sherry Fino wine

➔ LENTILS TREATMENTS:



CONTROL
GROUP OF
LENTILS



Ar-N₂(I)



Ar-N₂ (II)



Ar-N₂O



Action of a SWDs on Food: lentils and Sherry Fino wine



SHERRY FINO WINE TREATMENTS:



Mixture Ar-N₂ gas
(4.90 - 0.10 slm)



Ar Post-discharge
(4.90 slm)

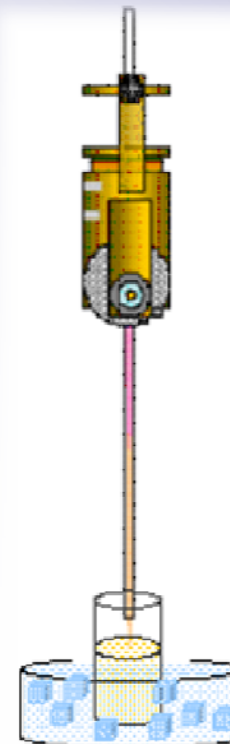

Ar-N₂ Post-discharge
(4.90 - 0.10 slm)





Action of a SWDs on Food: lentils and Sherry Fino wine

➔ SHERRY FINO WINE TREATMENTS:

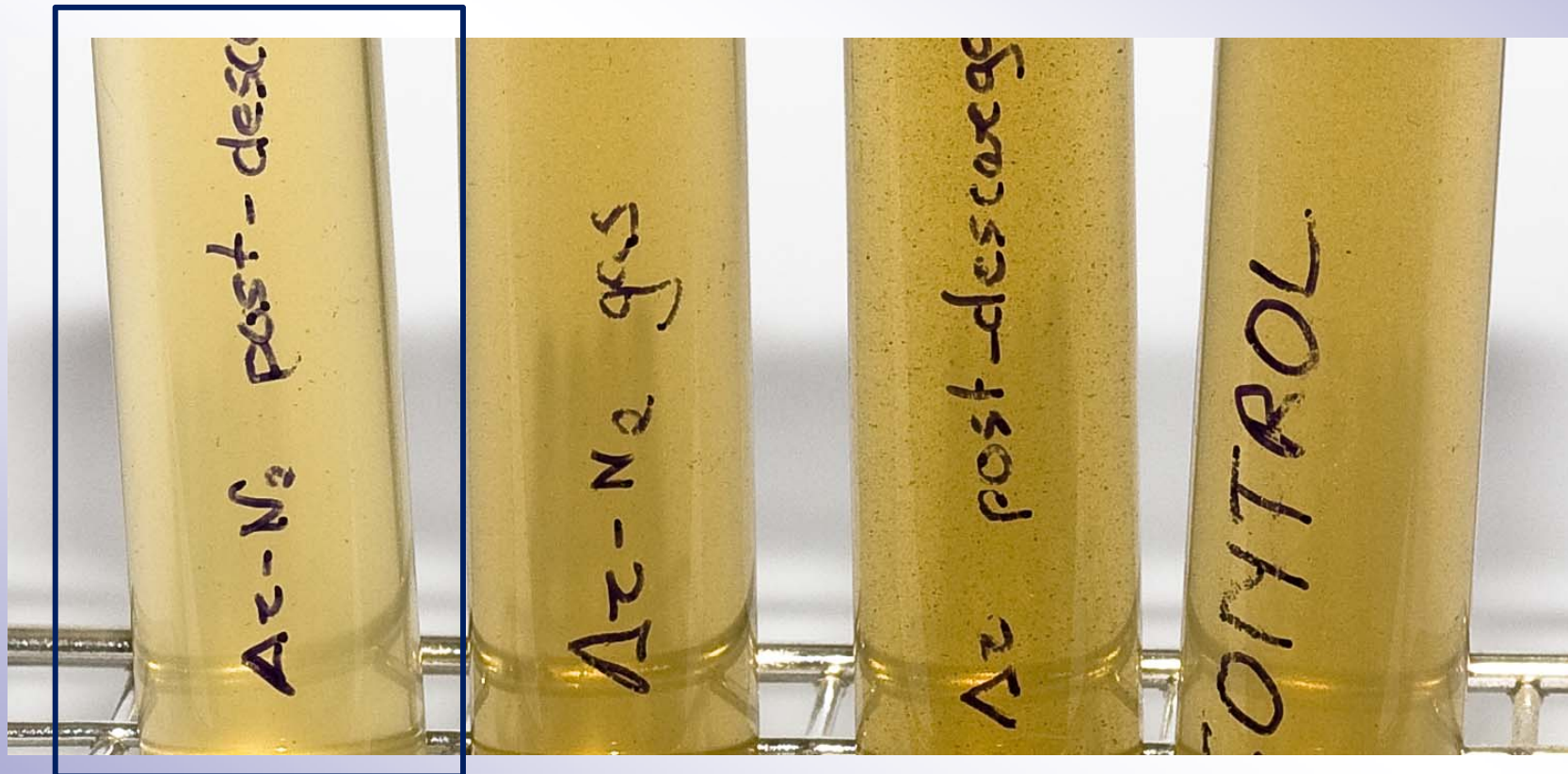



Action of a SWDs on Food: lentils and Sherry Fino wine

➔ **SHERRY FINO WINE TREATMENTS:**

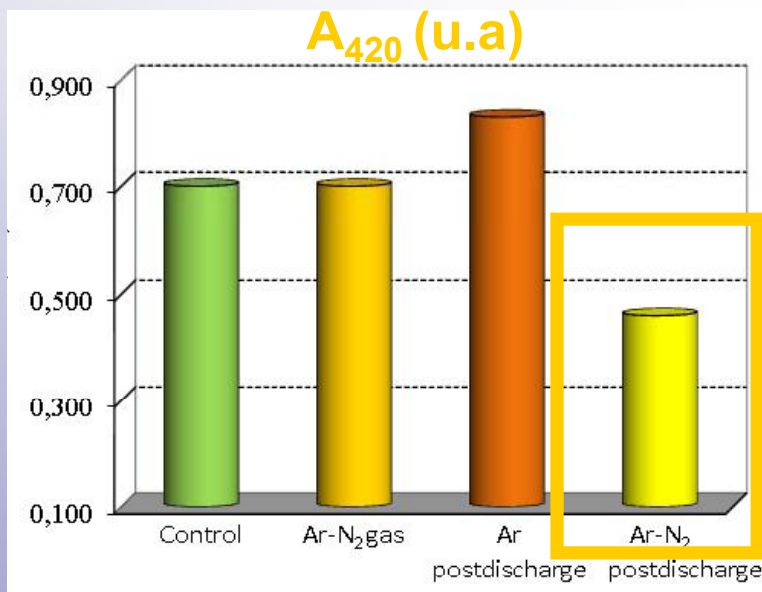

Parameters	Control	Ar-N ₂ Gas	Ar Post-discharge	Ar-N ₂ Post-discharge
a^*	1.96±0.02	2.30±0.01	3.26±0.02	-0.36±0.01
b^*	31.30±0.02	31.20±0.02	34.90±0.01	24.10±0.02
L_{ab}^*	82.40±0.03	81.90±0.04	78.60±0.02	90.10±0.04
A_{420nm}	0.701±0.010	0.701±0.010	0.829±0.020	0.459±0.010
A_{520nm}	0.257±0.020	0.265±0.010	0.318±0.010	0.14±0.010
A_{620nm}	0.130±0.010	0.135±0.020	0.166±0.020	0.062±0.020



Plasma Technology as a new Preservation Technique

- ➔ On the use of Plasma Technology as a food preservation Technique
- ➔ Active species and UV radiation un Surface Wave Discharges (SWDs)
- ➔ Action of a Surface Wave Discharge on browning of sherry Fino wine and growth rate in lentils
- ➔ **Conclusions**



Conclusions

The results suggest that plasma Technology could be a New Preservation Technique

- ➔ We have found that when we exposed lentils to plasma, those samples treated with plasma where exists active species and emission on UV photons grow less than the others samples
- ➔ The exposure of wine to an Ar-N₂ postdischarge could be used as a technique to increasing the resistance of the Fino wines to browning

Emission spectroscopy is an important tool to assess the capability of plasma technology as a preservation technique



Progress Report

University of Córdoba- Physics Department

Plasma Technology as a new Preservation Technique

R. Rincón and M. D. Calzada

June 2011

